

TITLE: PRIORITY SEWER TUNNEL - PHASE 2 (PST II)
GENERAL ARRANGEMENT
TUNNEL SHAFT S09A-SECTIONAL ELEVATION
TCE.10255A-CV-3057-GA-31031
DC ON DWG

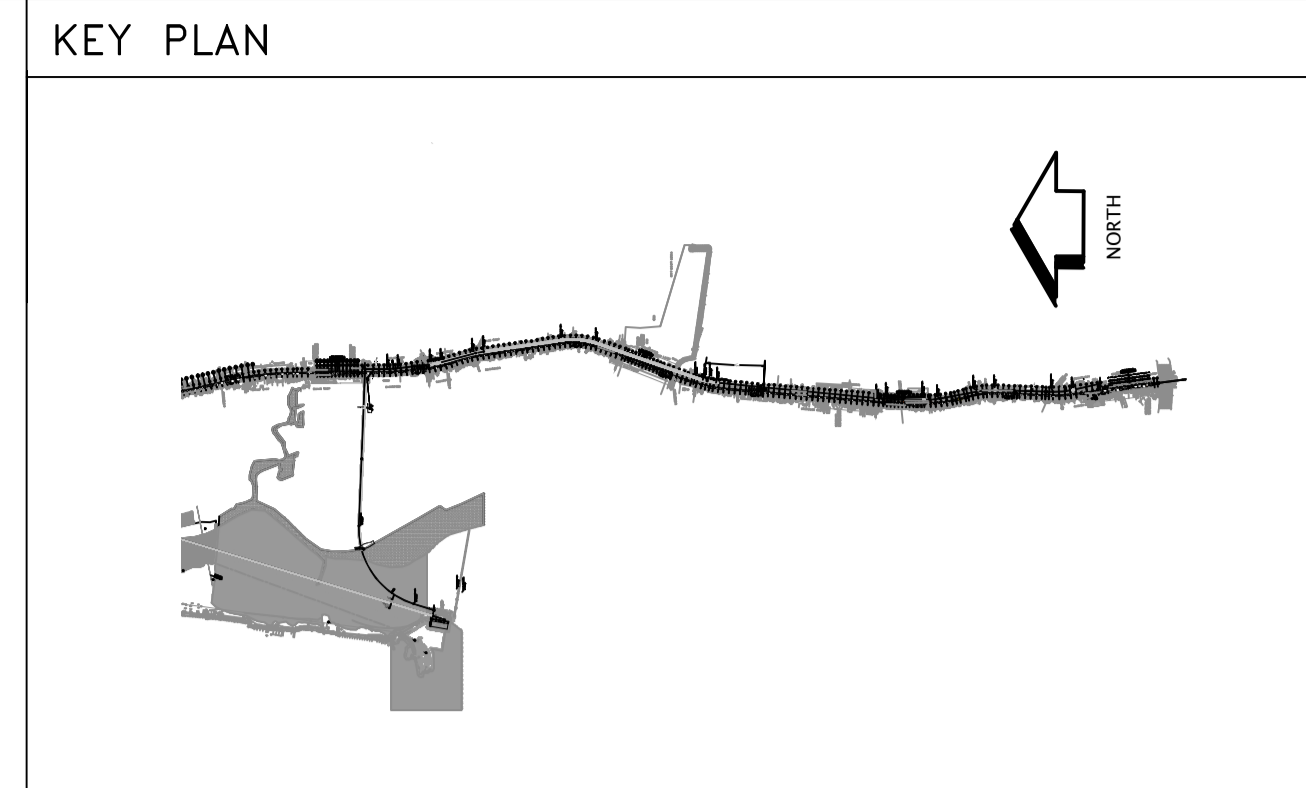

- NOTES:
- ALL DIMENSIONS ARE IN MILLIMETERS AND LEVELS ARE IN METERS UNLESS OTHERWISE INDICATED.
 - ALL CONCRETE TO BE GRADE M50 EXCEPT WHERE OTHERWISE STATED.
 - SHAFTS ARE TO BE MADE WATER TIGHT.
 - SEWER GRADIENTS TO BE MAINTAINED ACROSS MANHOLE.
 - STRUCTURAL DESIGN OF THE PERMANENT WORKS IS BASED UPON THE SHAFT BEING CONSTRUCTED IN AN OPEN EXCAVATION AND BACKFILLED AROUND.
 - DIMENSIONS OF PERMANENT STRUCTURAL WORKS SHOWN ARE INDICATIVE. THE CONTRACTOR SHALL DESIGN THE PERMANENT STRUCTURAL WORKS TO THE APPROVAL OF THE ENGINEER, TO SUIT THE CONTRACTOR'S METHOD OF WORKING AND TEMPORARY WORKS. CONTRACTOR TO SUBMIT CONSTRUCTION METHODOLOGY OF TEMPORARY AND PERMANENT WORKS TO THE APPROVAL OF THE ENGINEER.
 - SHAFT INTERNAL DIAMETER GIVEN IS THE MINIMUM TO BE PROVIDED.
 - FINISHED GROUND LEVEL TO MATCH EXISTING ROAD LEVEL.
 - INVERT LEVELS MAY VARY SLIGHTLY DURING EXECUTION.

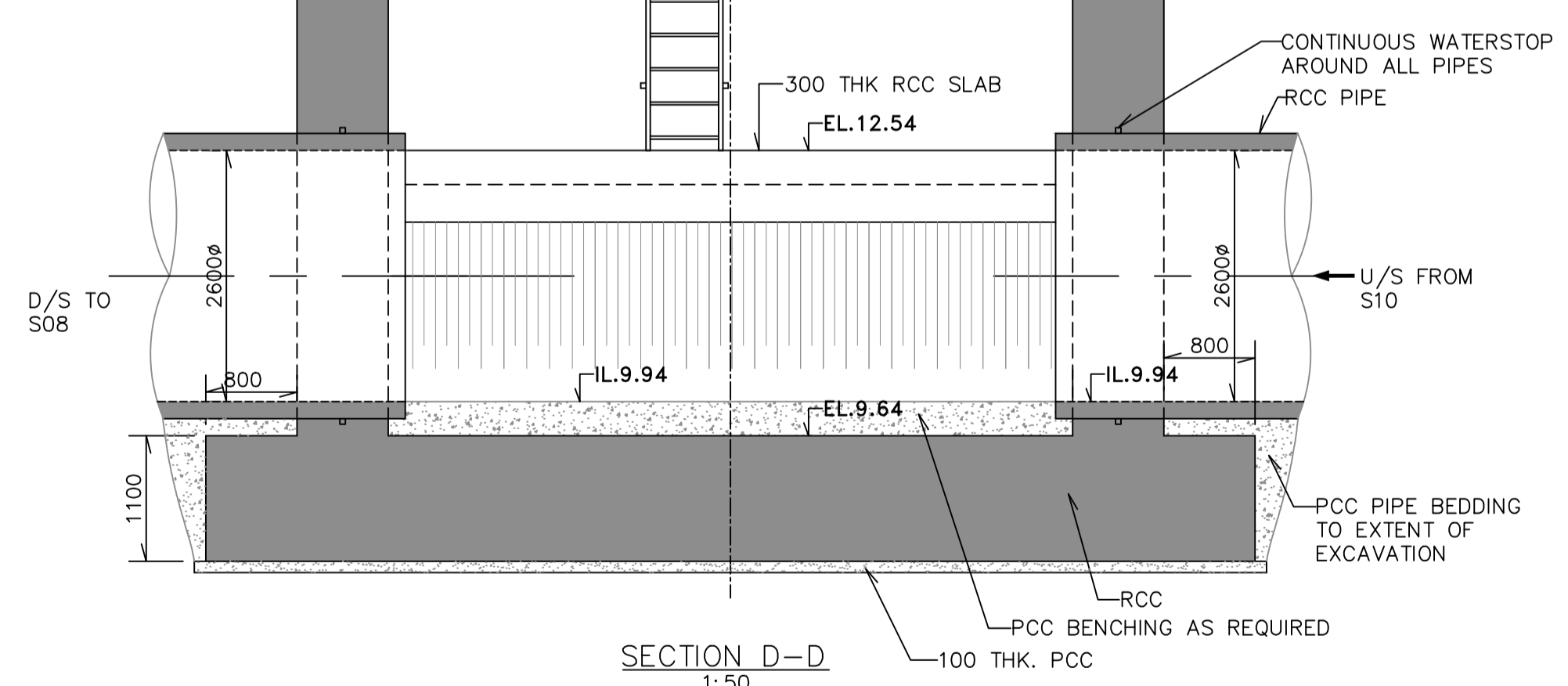
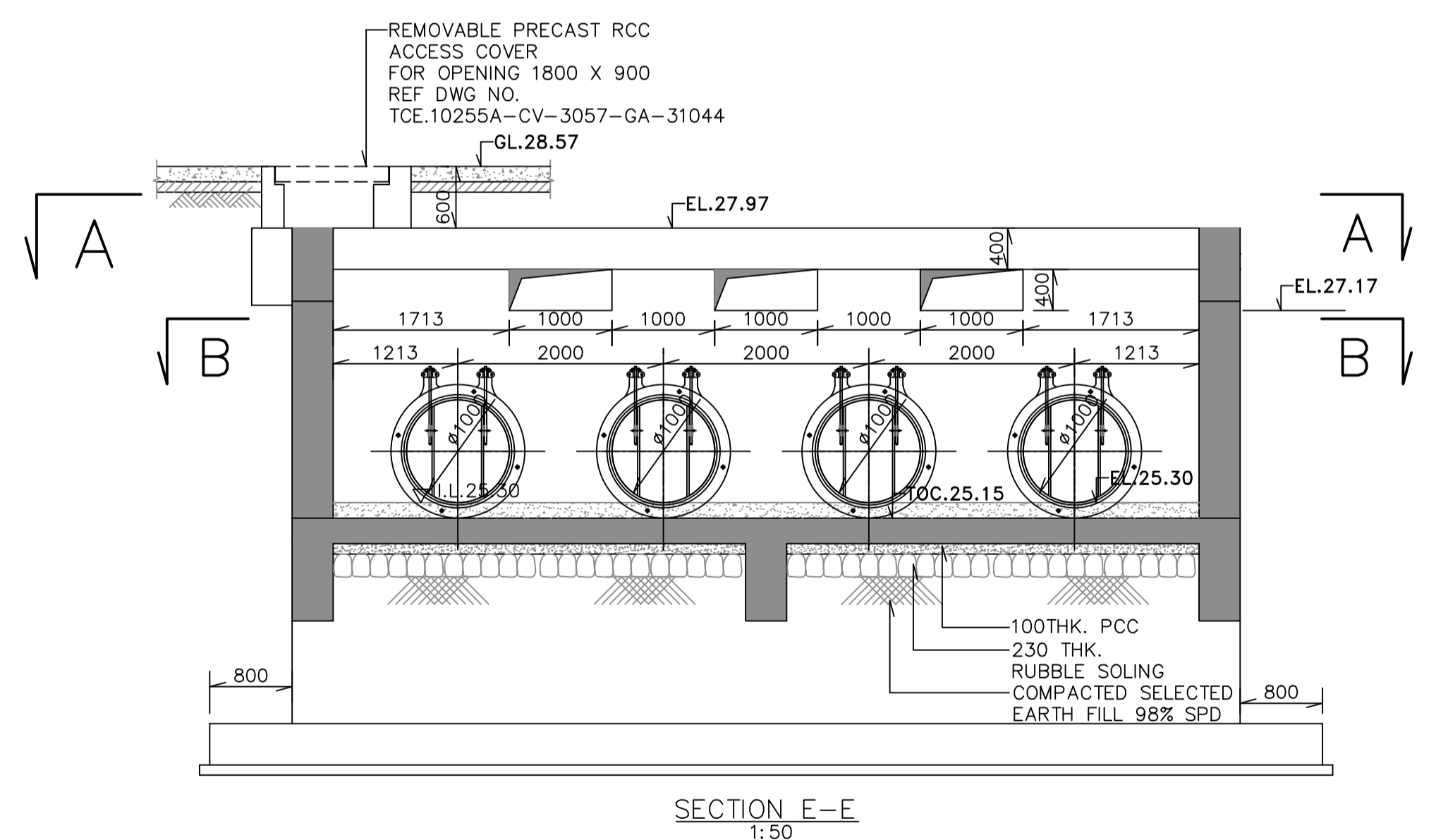
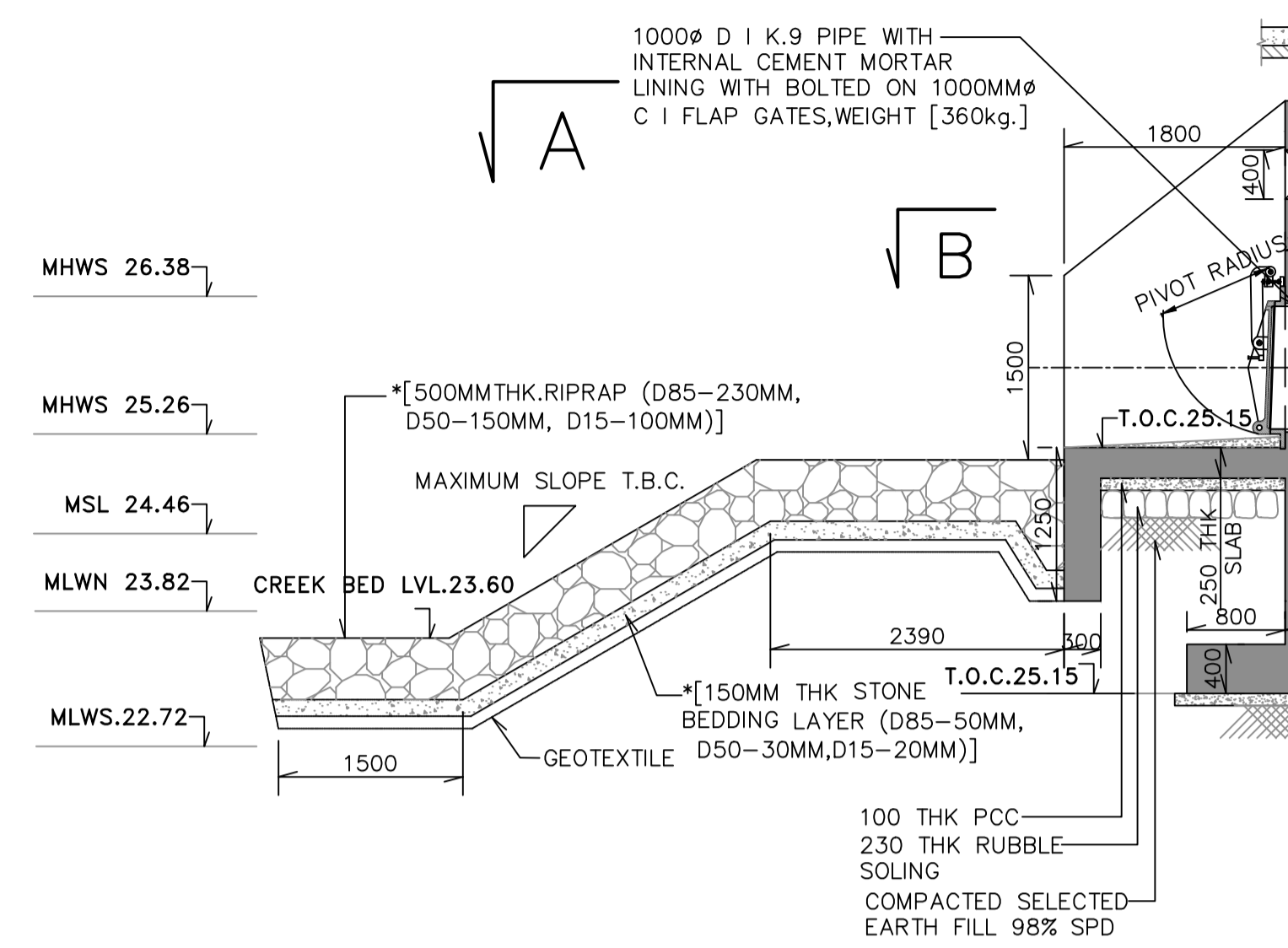
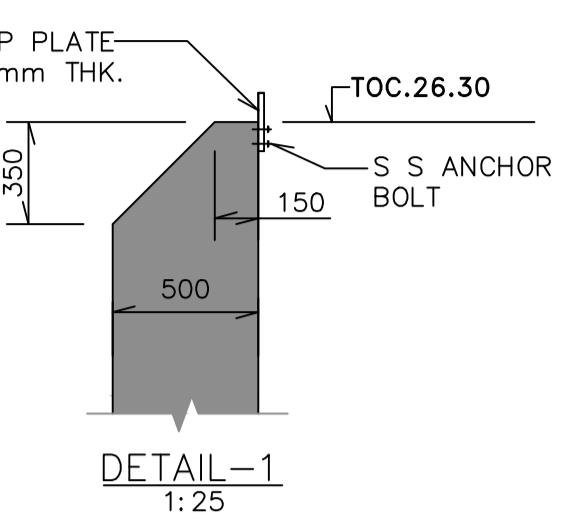
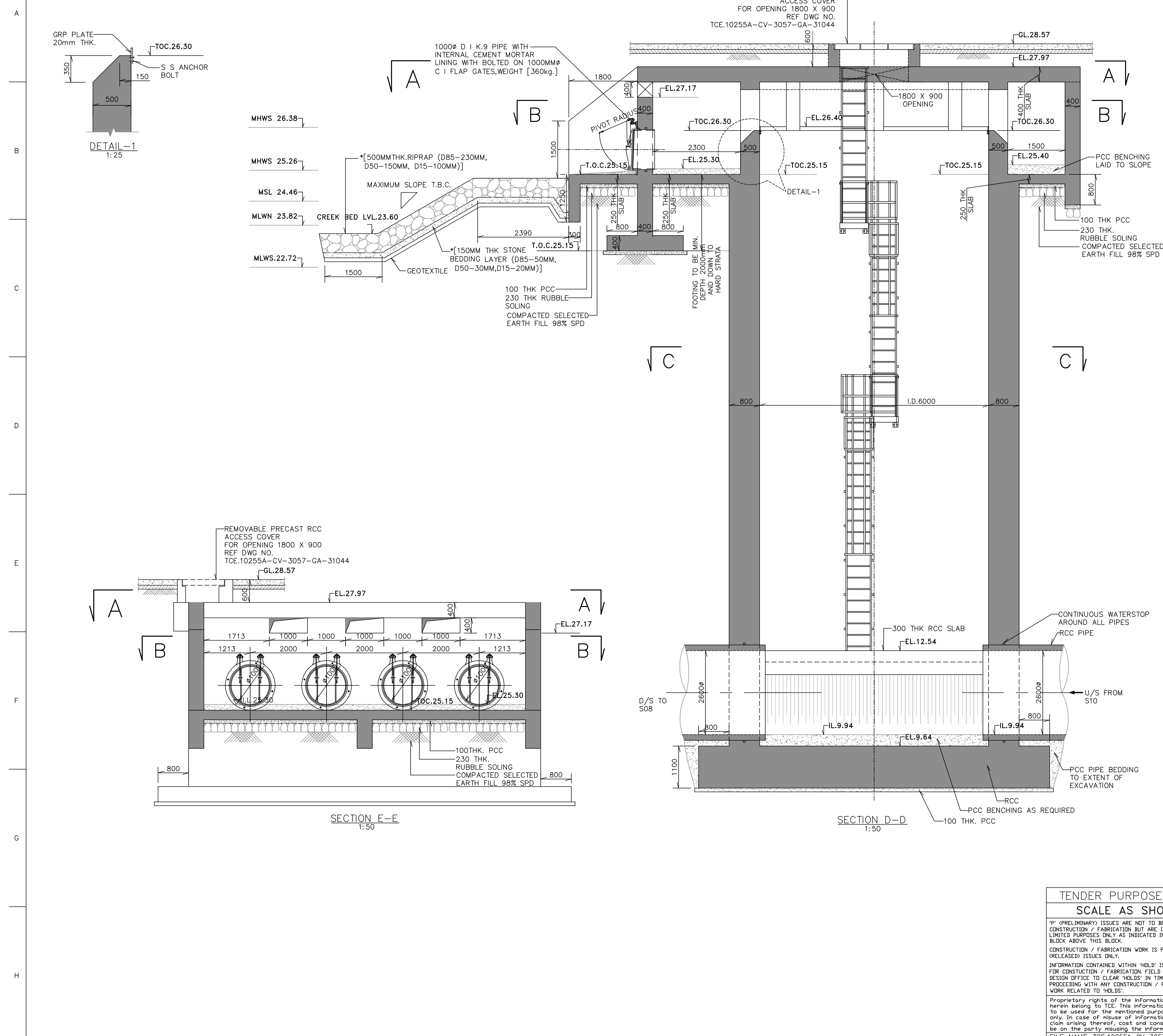
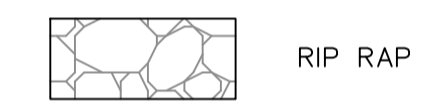

SIGN.																		
INITIALS																		
REVISIONS																		
SIGN.																		
INITIALS																		
REVISIONS																		
SIGN.																		
INITIALS																		
REVISIONS																		
SIGN.																		
INITIALS																		
REVISIONS																		
ISSUE																		

TENDER PURPOSE ONLY
SCALE AS SHOWN
'P' (PRELIMINARY) ISSUES ARE NOT TO BE USED FOR CONSTRUCTION / FABRICATION BUT ARE ISSUED FOR LIMITED PURPOSES ONLY AS INDICATED IN THE SMALL BLOCK ABOVE THIS BLOCK.
CONSTRUCTION / FABRICATION WORK IS PERMITTED ON 'R' (RELEASED) ISSUES ONLY.
INFORMATION CONTAINED WITHIN 'HOLD' IS NOT RELEASED FOR CONSTRUCTION / FABRICATION. FIELD MUST GET DESIGN OFFICE TO CLEAR 'HOLD'S' IN TIME BEFORE PRECEEDING WITH ANY CONSTRUCTION / FABRICATION WORK RELATED TO 'HOLD'S'.
Proprietary rights of the information contained herein belong to TCE. This information is intended to be used for the mentioned purpose/project only. In case of misuse of information and any claim arising therefrom, cost and consequence will be on the party misusing the information.
FILE NAME: TCE.10255A-CV-3057-GA-31031

MUNICIPAL CORPORATION OF GREATER MUMBAI
MUMBAI SEWAGE DISPOSAL PROJECT STAGE II-PRIORITY WORKS
PRIORITY SEWER TUNNEL - PHASE 2 (PST II)
GENERAL ARRANGEMENT
TUNNEL SHAFT S09A-SECTIONAL ELEVATION
TATA CONSULTING ENGINEERS LIMITED
MUMBAI
SCALE : AS SHOWN DWG. NO. TCE.10255A-CV-3057-GA-31031
ISSUE P1
DC & DISC: MUM CV TCE FORM NO. 091 RD